

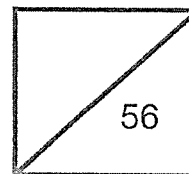

Rosyth School
Preliminary Examination for 2021
SCIENCE
Primary 6



Name: _____

Marks: _____

Class: Pr 6 _____ Register No. _____

Duration: 1 h 45 min

Date: 26th August 2021

Parent's Signature: _____

Booklet A

Instructions to Pupils:

1. Do not open the booklet until you are told to do so.
2. Follow all instructions carefully.
3. This paper consists of 2 Booklets, Booklet A and Booklet B.
4. For questions 1 to 28 in Booklet A shade the correct ovals on the Optical Answer Sheet (OAS) provided using a 2B pencil.

*** This booklet consists of 17 pages (inclusive of the cover page).**

This paper is not to be reproduced in part or whole without the permission of the Principal.

For each question from 1 to 28, four options are given. One of them is the correct answer. Make your choice (1, 2, 3 or 4). **Shade the correct oval (1, 2, 3 or 4) on the Optical Answer Sheet.** (56 Marks)

- 1 What is the common characteristic of all birds?
- (1) They can fly.
 - (2) They have three body parts.
 - (3) They reproduce by laying eggs.
 - (4) Their young do not look like the adults.
- 2 Which characteristic(s) can be used to classify a tomato plant, a bird nest fern and a mushroom into two groups?
- A: Ways of reproduction
 - B: Ways of obtaining food
 - C: Flowering or non-flowering plants
- (1) A only
 - (2) A and B only
 - (3) B and C only
 - (4) A, B and C
- 3 A group of living things was observed under a microscope over three days.

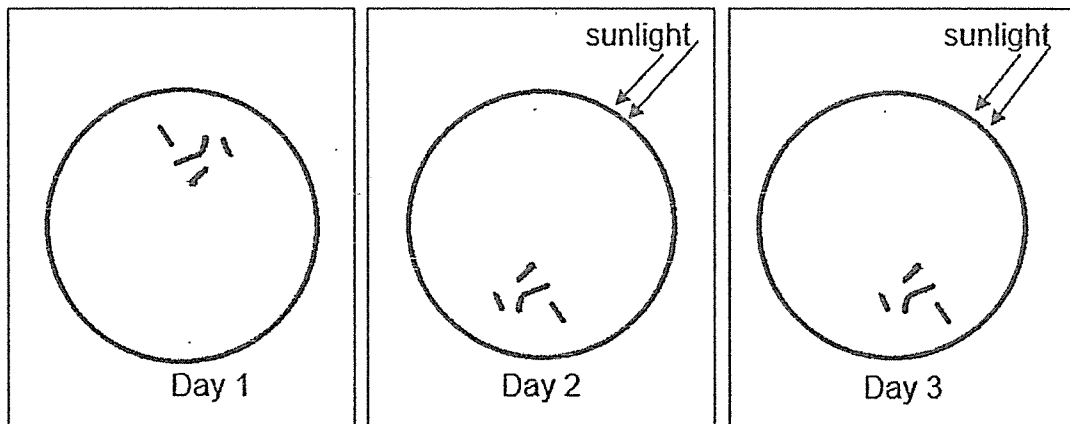

Which characteristic of living things was shown over the three days?

- (1) Living things can die.
- (2) Living things can grow.
- (3) Living things can respond.
- (4) Living things can reproduce.

4 Which cell shows the position of the nucleus correctly?

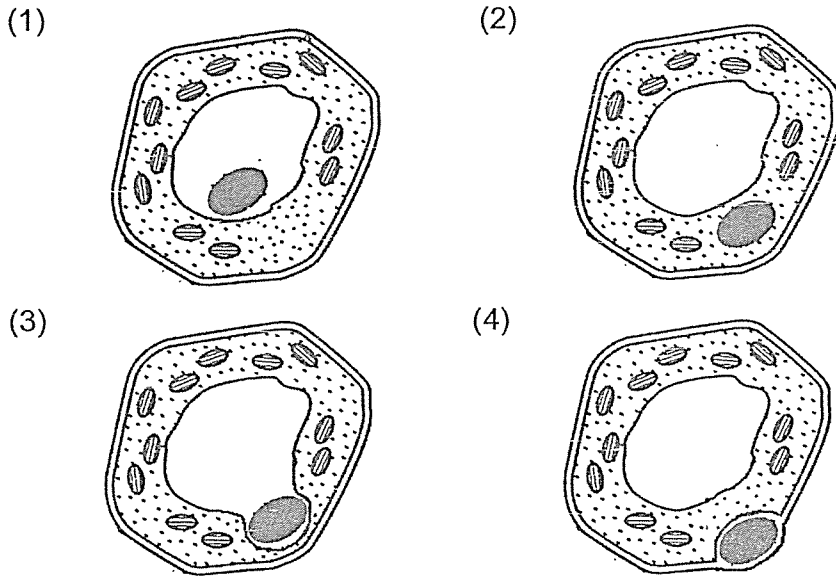

5 Study the life cycle of an animal.

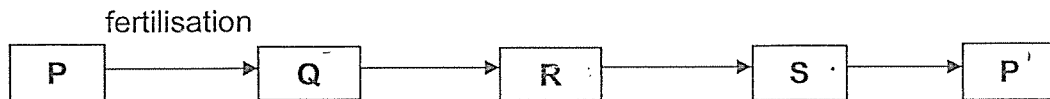

Which of the following correctly shows the animal and stage Q?

	Animal	Q
(1)	butterfly	egg
(2)	mosquito	adult
(3)	cockroach	adult
(4)	frog	egg

6 The diagram below shows a seedling of a plant.

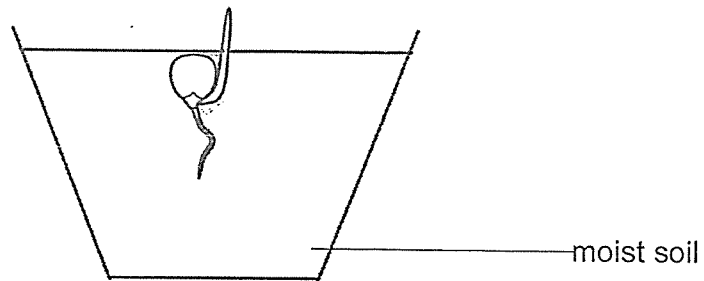

What is the direction of the transport of water and food in the seedling?

	water	food
(1)	upwards	upwards only
(2)	downwards	upwards and downwards
(3)	downwards	downwards only
(4)	upwards	upwards and downwards

7 The diagram below shows the parts of a female reproductive system of a human and a flower.

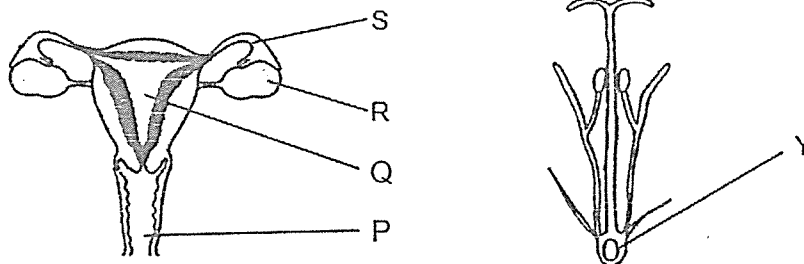

Which part of the female human reproductive system has a similar function as Y?

- (1) P
- (2) Q
- (3) R
- (4) S

- 8 Noel pruned an overgrown tree by cutting off some of the branches.

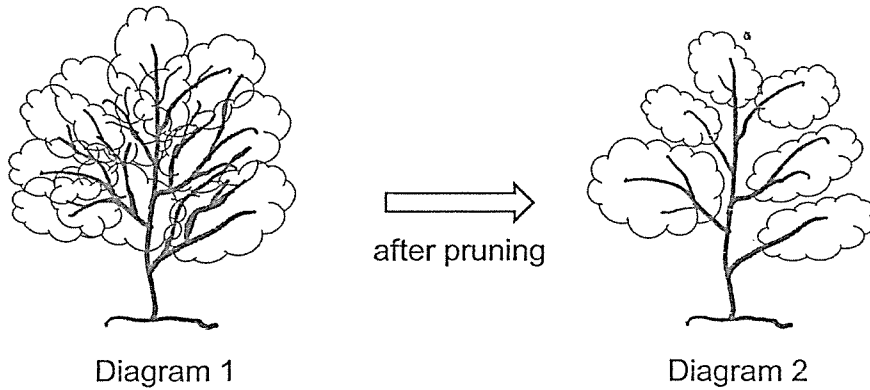

Compared to Diagram 1, the cutting of branches in Diagram 2 reduces competition for _____.

- (1) air
 - (2) food
 - (3) sunlight
 - (4) pollinators
- 9 _____ is the primary source of energy.

- (1) Sun
- (2) Plant
- (3) Animal
- (4) Decomposer

- 10 Olsen wanted to find out how much water plants will take in. Which set-up should she choose to get the most accurate result?

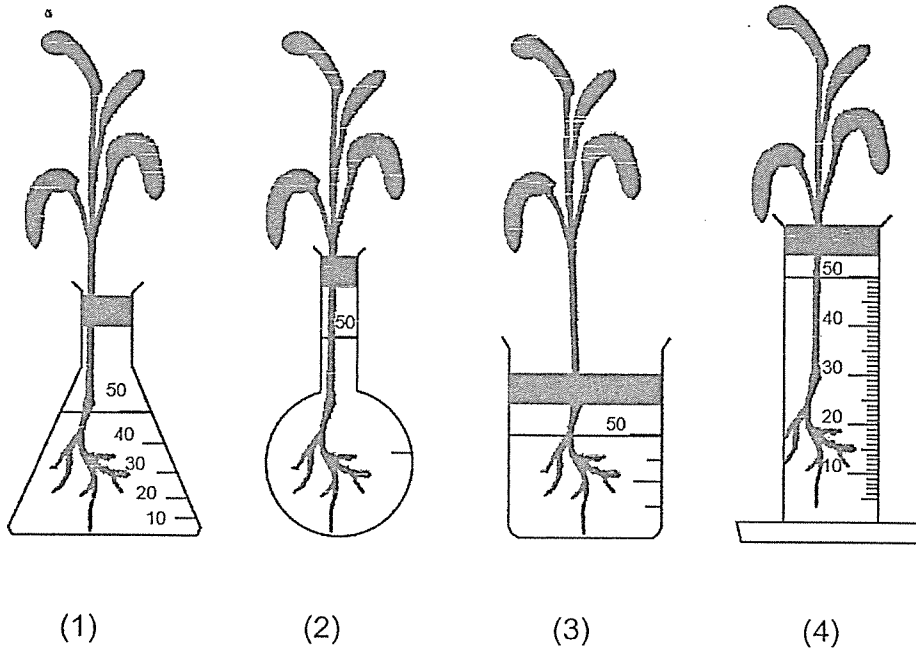

- 11 The diagram shows a watermelon plant. The plant stores sugar in the watermelon and farmers add mineral salt K to the soil to make the watermelon even sweeter.

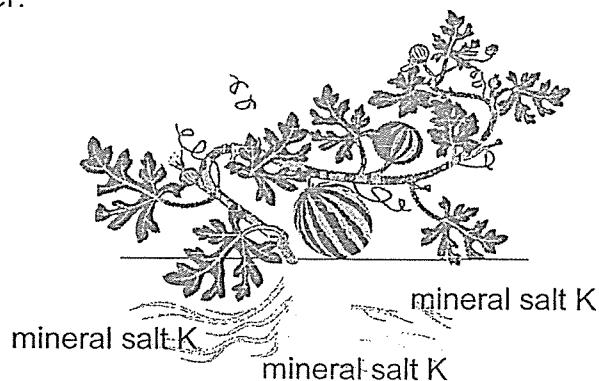

Which of the following describes the movement of sugar and mineral salt K?

	mineral salt K transported by	sugar transported by
(1)	food-carrying tube	food-carrying tube
(2)	food-carrying tube	water-carrying tube
(3)	water-carrying tube	food-carrying tube
(4)	water-carrying tube	water-carrying tube

- 12 An experiment is set up as shown. The volume of gas collected is measured after 20 minutes.

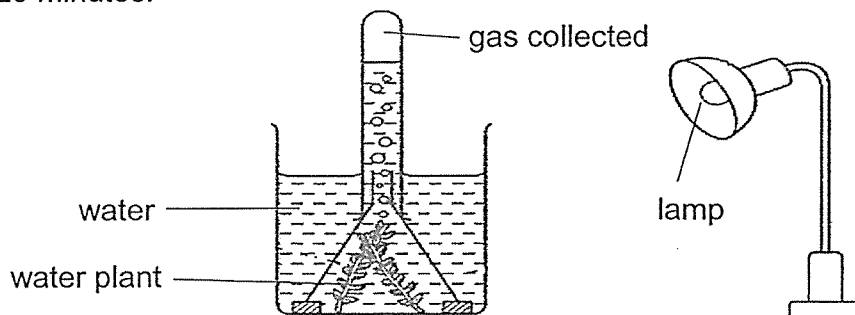

The experiment is repeated several times. Each time the light intensity is increased. Which graph shows the result?

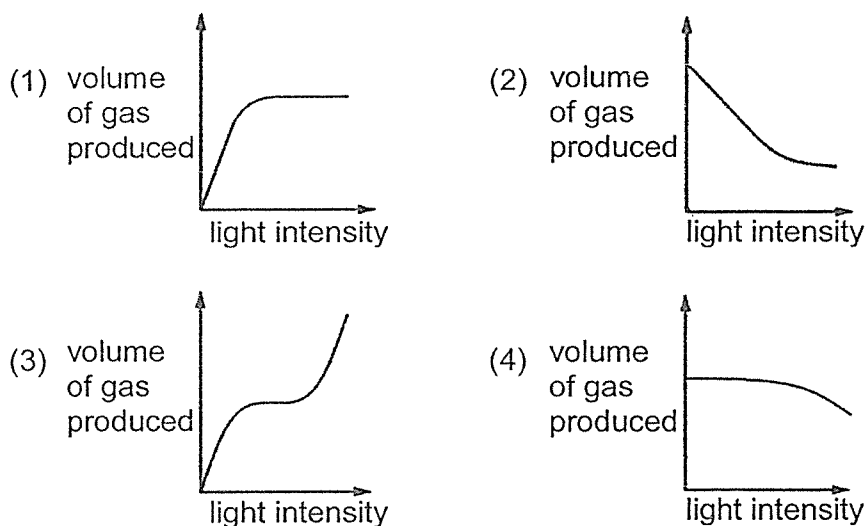

- 13 Which one of the following is a similarity between the small intestine and large intestine?

- (1) Both produce digestive juices.
- (2) Both absorb digested food and water.
- (3) Undigested food can be found in both of them.
- (4) Digested food and undigested food can be stored in both of them.

- 14 When starch is mixed with saliva, it is broken down into sugar. Tom prepared four set-ups, F, G, H and J for his investigation as shown below.

Set-up	Amount of starch (ml)	Amount of saliva (ml)	Temperature of mixture (°C)	Number of stirs of mixture
F	25	30	40	0
G	20	35	33	10
H	20	30	33	0
J	25	30	40	10

Using two of the above set-ups, which one of the following could be the aim of Tom's investigation?

Set-ups	Aim of the investigation
(1) F and G	To find out if the amount of saliva affects the rate starch is broken down into sugar.
(2) G and H	To find out if the amount of starch affects the rate starch is broken down into sugar.
(3) F and H	To find out if the temperature of mixture affects the rate starch is broken down into sugar.
(4) F and J	To find out if the number of stirs of mixture affects the rate starch is broken down into sugar.

- 15 The diagram shows a pair of shoes.

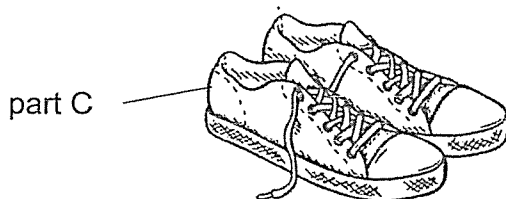

To wear comfortably, it is most important for part C of the shoe to have the property of _____.

- (1) strength
- (2) flexibility
- (3) waterproof
- (4) ability to float on water

- 16 A compass has a small magnet that can move freely.

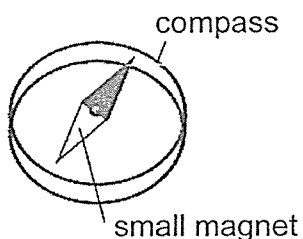

Which diagram shows the directions of the small magnets in the compass correctly?

- (1) (2)
- (3) (4)

- 17 There is a lighted candle and a toy behind a screen.

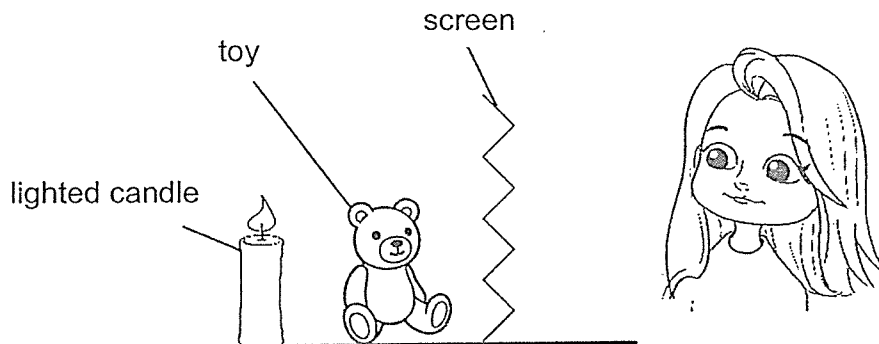

Which of the following explains why Nadiah cannot see the toy?

- (1) No light is entering Nadiah's eyes.
- (2) The toy is not reflecting any light.
- (3) Only some light can pass through the screen.
- (4) No light is reflected from the toy into Nadiah's eyes.

- 18 Mala set up an experiment as shown below in a dark room. The light sensor gave a reading of 30 units.

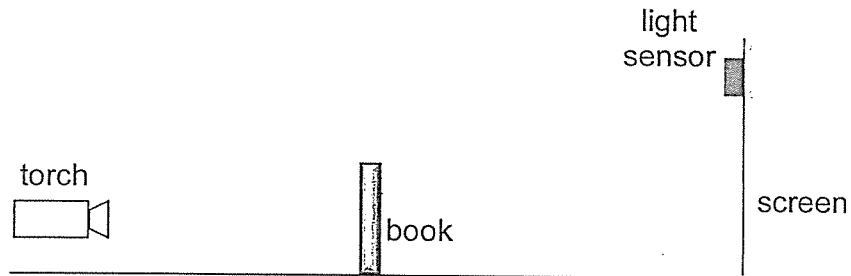

When Mala moved one object in the set-up, the reading on the light sensor increased to 50 units and dropped to 0 units suddenly.

Which object did Mala move and in which direction?

- (1) Moved book towards the torch.
 - (2) Moved screen towards the book.
 - (3) Moved torch towards the screen.
 - (4) Moved torch away from the book.
- 19 The diagram below show four identical syringes. Which syringe can be pushed in the most?

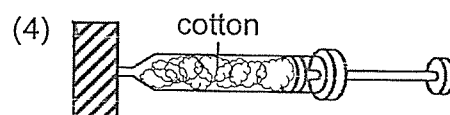
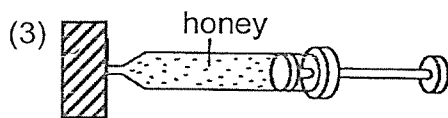
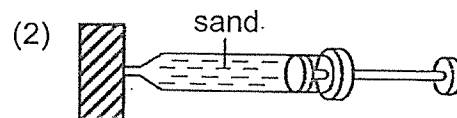
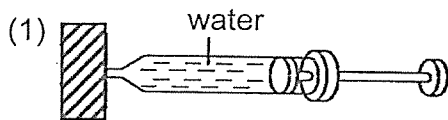

20 The diagram below shows Jyak blowing air into a balloon.

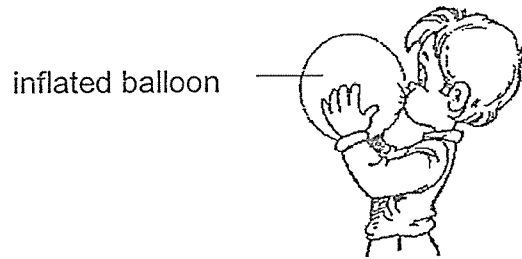

The inflated balloon is bigger because air _____.

- (1) has mass
- (2) occupies space
- (3) has indefinite shape
- (4) has indefinite volume

- 21 Simon wanted to compare the heat conductivity of metals using the set-up as shown below. A piece of wax of the same size was placed on each end of the rods which was supported by the wooden ring. The rods were then heated at position X of the set-up.

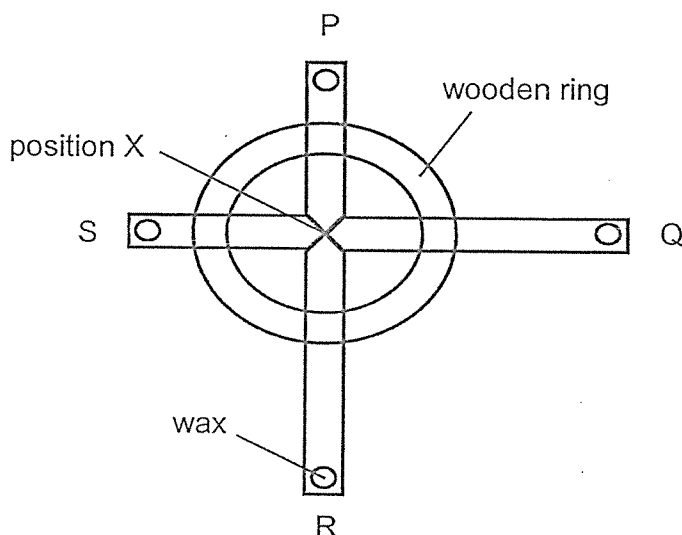

The table shows the information regarding the metal rods, P, Q, R and S.

Rods	Length of rod (cm)	Thickness of rod (cm)
P	10	0.5
Q	20	0.5
R	20	0.5
S	10	0.5

Simon observed that the wax on rod S dropped first, followed by that on rod R, P and Q.

Based on the results, which of the following conclusion is correct?

- (1) S is the best conductor of heat.
- (2) Q is the worst conductor of heat.
- (3) R is a better conductor of heat than P.
- (4) P is a better conductor of heat than Q.

22 The diagram shows the water cycle.

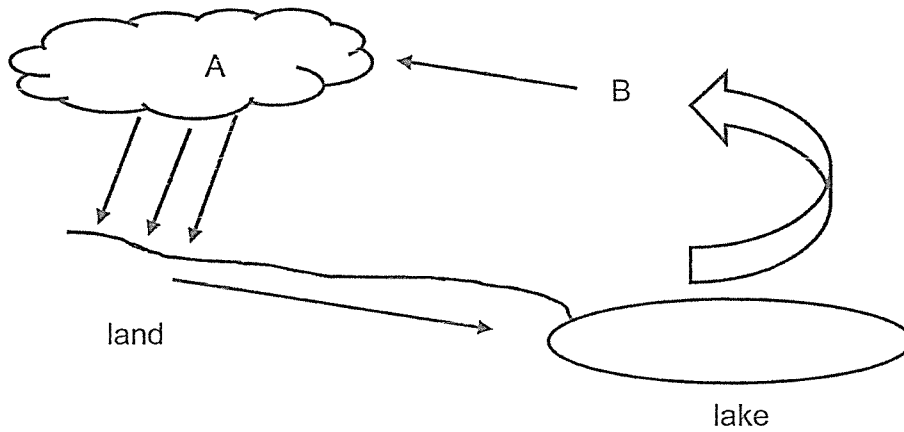

Which of the following shows the correct state of matter of water when it is at A and B?

	A	B
(1)	solid	gaseous
(2)	liquid	liquid
(3)	liquid	gaseous
(4)	gaseous	solid

23 The diagram below shows some bees flapping their wings above a honeycomb to thicken the nectar. At first, the nectar in the honeycomb was watery.

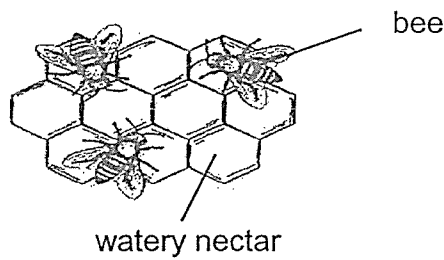

The flapping of the wings causes _____.

- (1) the nectar to cool faster
- (2) the nectar to evaporate faster
- (3) the water content to evaporate faster
- (4) heat to be transferred from the bees to the nectar

24 Study the electric circuit below.

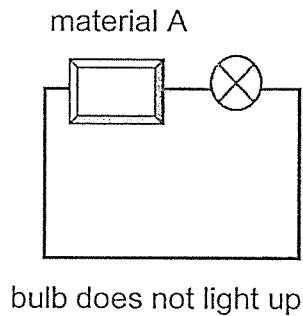

Which of the following is definitely the reason for the bulb not to light up?

- (1) The bulb is fused.
- (2) There is no switch.
- (3) There is no battery.
- (4) Material A is an insulator of electricity.

25 Ziming set up two identical bulbs in his toy house. Bulb X is in Room 1 and Bulb Z is in Room 2. The brightness of each room is the same. The two rooms are separated by a wall as shown below.

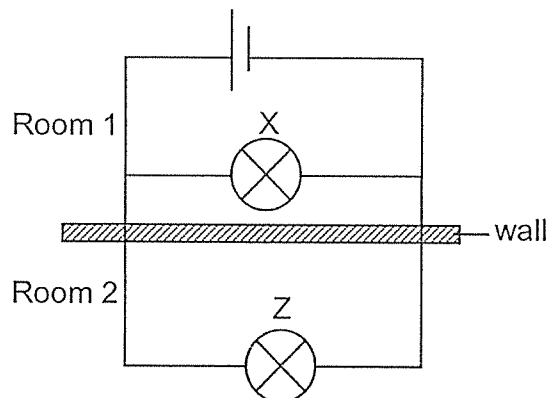

He wanted Room 2 to be brighter than Room 1.

What should he do?

- (1) Add in a bulb in series to bulb Z.
- (2) Add in a bulb in parallel to bulb Z.
- (3) Add in more batteries in the circuit.
- (4) Add in an electrical conductor in series to bulb Z.

26 The diagram shows a power station.

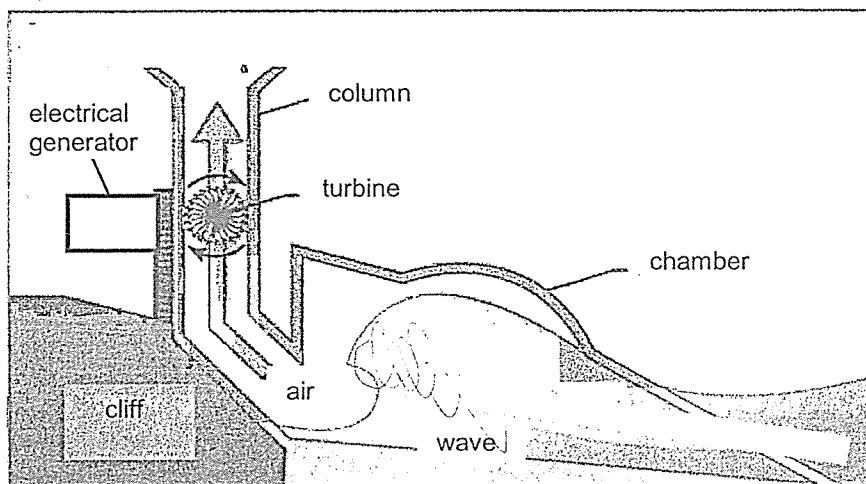

When the sun warms up the surface of the Earth, it causes the air to move, resulting in winds. The wind passes over the ocean, transferring its kinetic energy to the water below, generating waves.

Based on the information above, which of the following shows the energy conversion to generate electricity?

- (1) potential energy → electrical energy
- (2) heat energy → kinetic energy → electrical energy
- (3) potential energy → kinetic energy → electrical energy
- (4) heat energy → potential energy → kinetic energy → electrical energy

- 27 Ali held a phone by the wire as shown in diagram 1. After a few seconds, the phone dropped to the ground as shown in diagram 2.

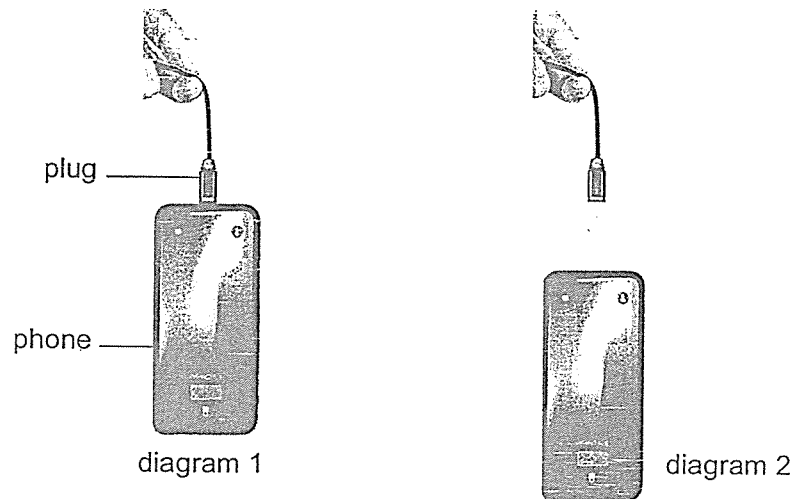

The phone dropped because the _____.

- (1) weight of the phone acted against the gravitational force
- (2) friction between the plug and the phone is less than the weight of the phone
- (3) weight of the phone was greater than the total weight of the phone and the plug
- (4) friction between the plug and the phone is greater than the weight of the phone

- 28 Peifen wanted to compare the stiffness of springs of the same length using the set-up as shown below.

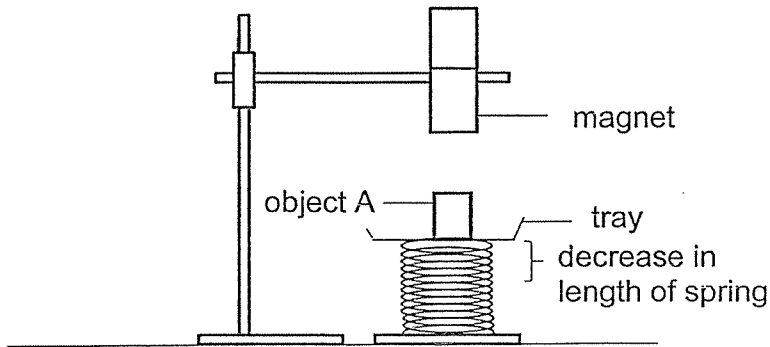

She placed object A on spring X with a magnet suspended at the same height above it and measured how much the spring decreased. She then repeated the same experiment using springs Y, Z and W. The results are shown in the table below.

Springs	Mass of objects (g)	Decrease in length of spring (cm)
W	10	1
X	10	3
Y	10	2
Z	10	4

When the springs are hung from the ceiling using four identical blocks, which of the following shows the correct results?

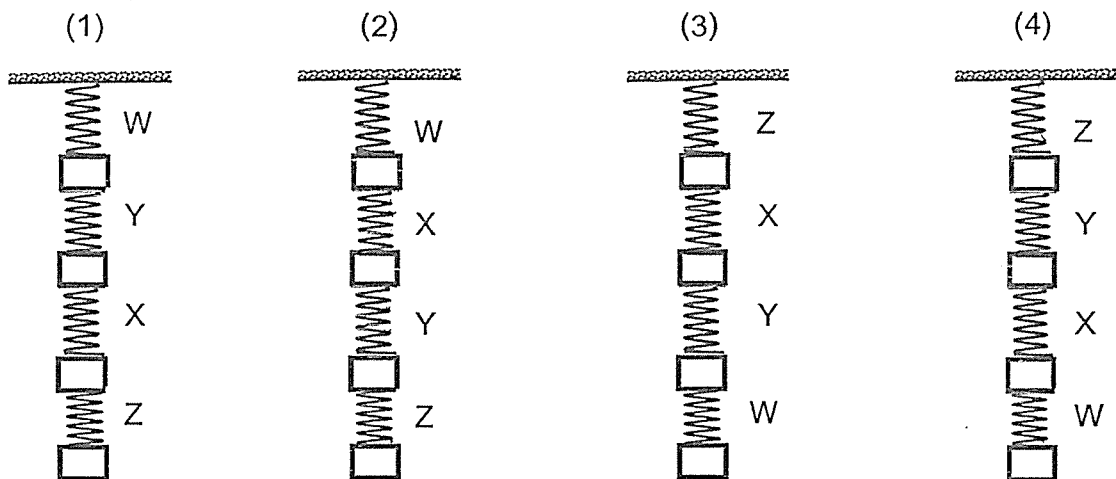

END OF BOOKLET A

(go on to Booklet B)



Rosyth School
Preliminary Examination for 2021
SCIENCE
Primary 6

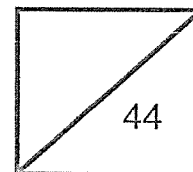

Name: _____

Marks: _____

Class: Pr 6 _____ Register No. _____ Total Time for Booklets A and B : 1 h 45 min

Date: 26th August 2021

Parent's Signature: _____

Booklet B

Instructions to Pupils:

1. Do not open the booklet until you are told to do so.
2. Follow all instructions carefully.
3. For questions 29 to 40 in Booklet B, write your answers in the space provided.

	Maximum	Marks Obtained
Booklet A	56 marks	
Booklet B	44 marks	
Total	100 marks	

*** This booklet consists of 14 pages. (inclusive of the cover page)**

This paper is not to be reproduced in part or whole without the permission of the Principal.

For questions 29 to 40, write your answers in the space provided. (44 Marks)

- 29 Jay had two slices of bread in his kitchen. There was mould growing on both slices of bread. His sister said it is safe to eat the bread after toasting as heat kills the mould.

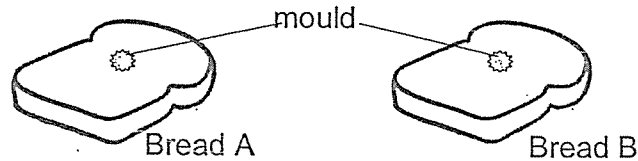

Jay wanted to find out if his sister was correct. He toasted the two slices of bread in a toaster at the same temperature for the same period of time. After toasting, he did the following to the slices of bread, A and B, as shown in the table below.

Toasted bread	What he did after toasting
A	sealed into a plastic bag immediately
B	sealed into a plastic bag after cooling

After few days, he made the following observations as shown below.

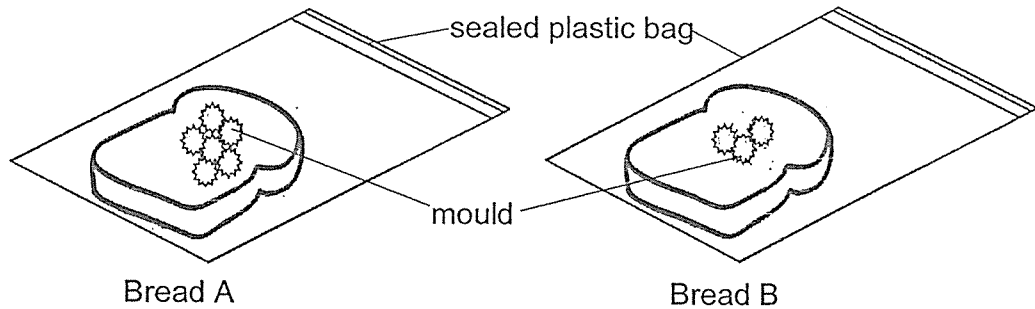

- (a) Do you agree with Jay's sister? Support with evidence. [1]

- (b) Explain the difference observed on bread A compared to bread B after a few days. [2]

30 The diagram below shows two stages in human reproduction.

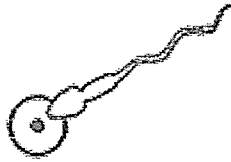

stage A

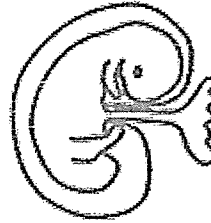

stage B

(a) What process is taking place at stage A? Describe what happens during this process. [2]

(b) How does the developing baby in stage B obtain food and oxygen to survive? [1]

31 (a) What is seed dispersal? [1]

Winnie conducted an investigation to find out if the length of the wings of two seeds, Y and Z, affects the distance travelled by them.

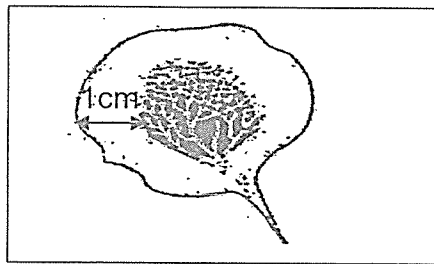

Seed Y

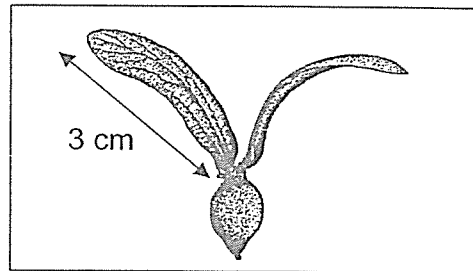

Seed Z

(b) Is it fair to compare the above seeds? Explain why. [1]

(c) What is the disadvantage of the method of dispersal of seeds Y and Z? [1]

- 32 In an experiment to investigate the condition necessary for food production by a plant, two similar well-watered potted plants were set up as shown in the diagram below. The percentage of carbon dioxide in the jar is measured after six hours and recorded in the table.

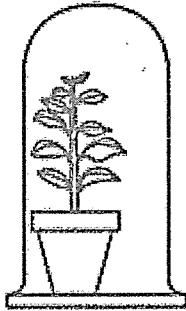
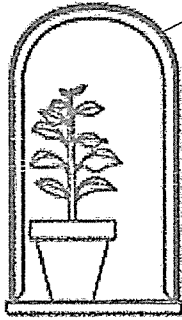
Set-up in a garden at noon	<p style="text-align: center;">P</p> 	<p style="text-align: center;">Q</p> 
Percentage of carbon dioxide in the jar after 6 h	0.03	0.05

- (a) State the condition investigated using the set-ups. [1]

- (b) What was the percentage of carbon dioxide in the jar at the start of the experiment? Support your answer. [2]

33 (a) Why do living things need food? [1]

(b) Riz placed 10g of food into each of the two set-ups.

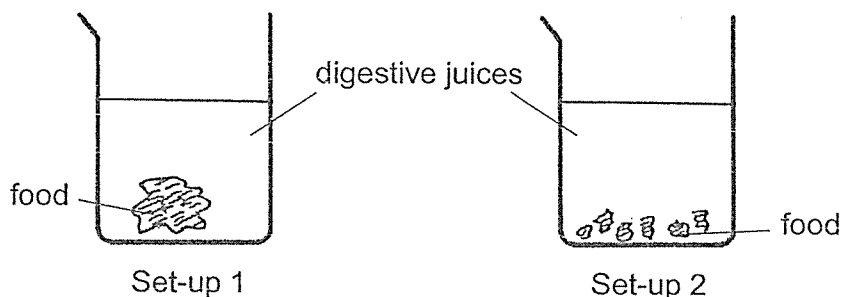

(i) Which part of the human body performs the function of what has been done to the food in set-up 2 compared to set-up 1? [1]

The two set-ups contain equal amount of digestive juices to digest the food. After some time, the food in one of the set-ups is fully digested.

(ii) In which of the two set-ups will the food be completely digested first? Explain your choice. [2]

(c) Study the diagram below. X and Y represent the blood flowing in the blood vessel.

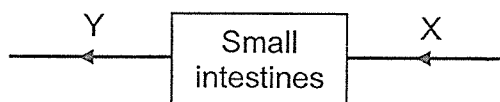

Name a substance in the blood which is higher in Y than in X. [1]

34 Sanjan carried out an experiment to measure the amount of oxygen supplied per minute to the brain after breathing at different rates.

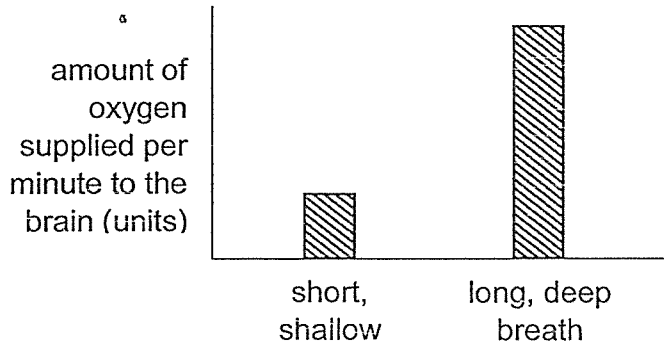

(a) Describe how oxygen in the surrounding air reaches the brain. [2]

(b) Suggest why taking long deep breath will allow more oxygen to be supplied to the brain. [1]

(c) Graph 1 shows the movement of air into and out of the lungs before exercise. Draw on graph 2 to show the movement of air into and out of the lungs immediately after a strenuous exercise for the same period of time. [1]

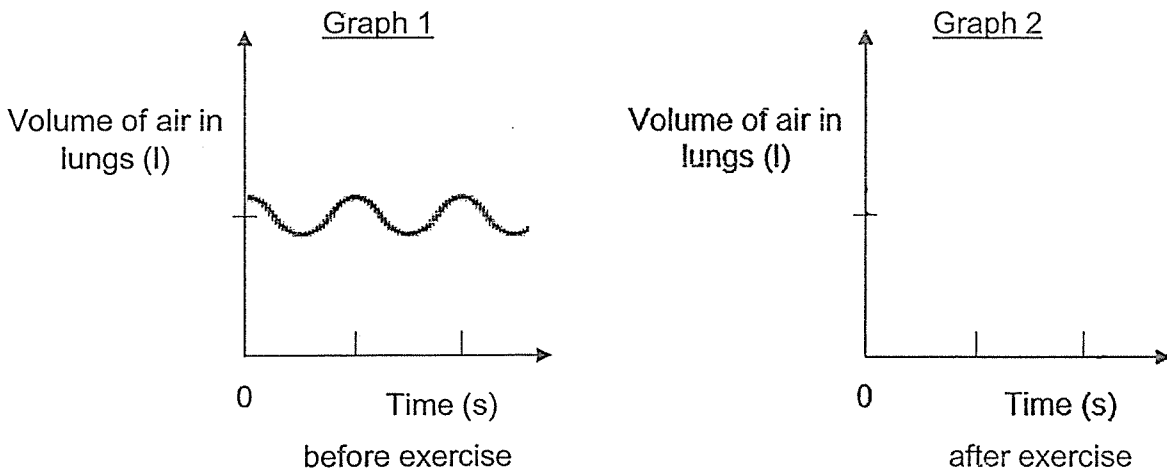

(d) Name a gas that remains the same during the movement of air into and out of the lungs. [1]

- 35 Paul wants to test the physical property of different materials. He pours 200ml of water onto material X and measured the volume of water collected in the beaker below.

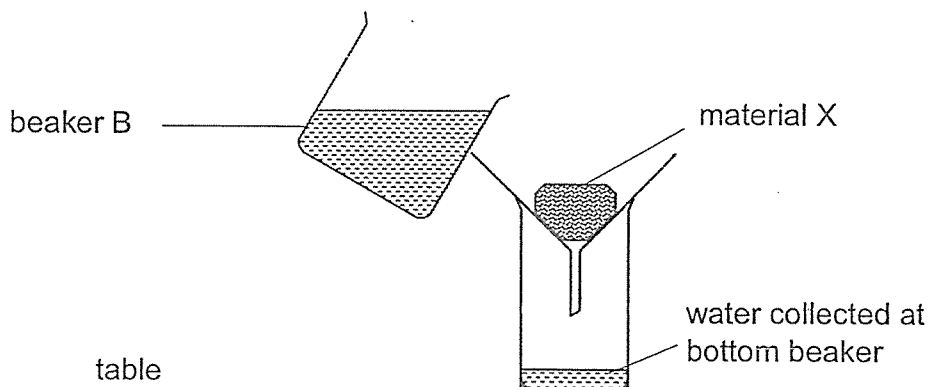

The procedure was repeated with materials Y and Z of similar size as material X. The volume of water collected was recorded.

Material	X	Y	Z
Volume of water collected at bottom beaker (ml)	180	170	200

- (a) What physical property of the materials was Paul testing? [1]

- (b) Paul pours the water gently from beaker B to prevent water from splattering when it hits the material. What else should he do to ensure that the water hits materials, X, Y and Z, with same amount of force to get a more accurate measurement? [1]

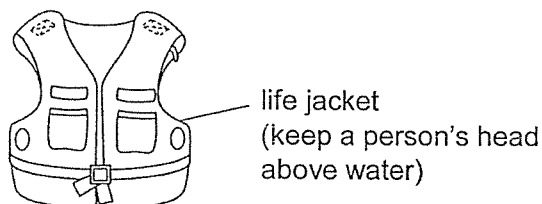

- (c) Which material, X, Y, or Z, is the most suitable to make a life jacket? Explain your answer. [2]

- 36 A group of students carried out an experiment to find out the factors affecting the temperature of the ice cream layer in the dessert as shown below. Although the dessert was placed in a hot oven, the ice cream inside remained frozen.

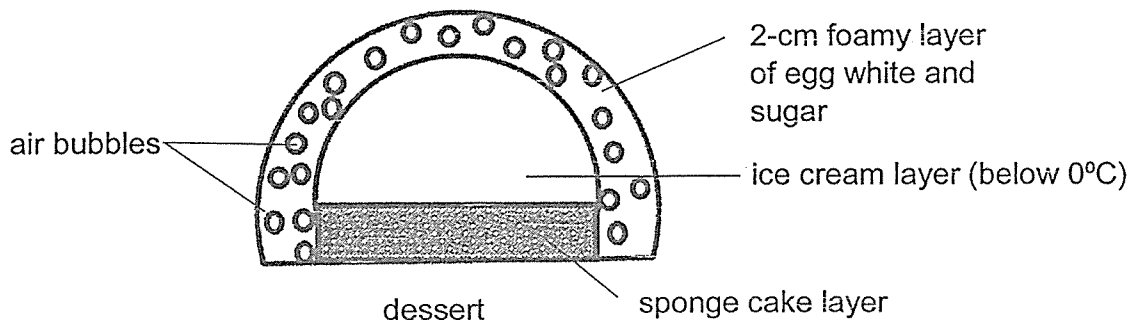

- (a) What is the property of heat of the air bubbles that prevented the ice cream from melting when placed in the hot oven? [1]

Next, the students also investigated using a 1-cm foamy layer and obtained the following observations as shown in the table below.

Thickness of foamy layer (cm)	Temperature of oven (°C)	Time taken for the ice cream layer to start melting (min)
2	250	12
1	250	8

- (b) Give a possible reason for the difference in the results of their investigation. [1]

(Question 36 continues on page 10)

The melting point of the ice cream layer is below 0°C.

- (c) State what melting means. [1]

- (d) Using an identical set-up as the 2-cm foamy layer, if the ice cream is replaced by ice, will the time taken for the ice to melt be faster or slower than 12 min? Explain why. [2]

- 37 Jeremy heated some ice cubes in a pan. After some time, all the ice cubes melted. He continued the heating until the water started to boil. He observed white clouds forming above the pan. He switched off the flame and covered the pan with a lid.

He then plotted a graph from the results of his experiment as shown below.

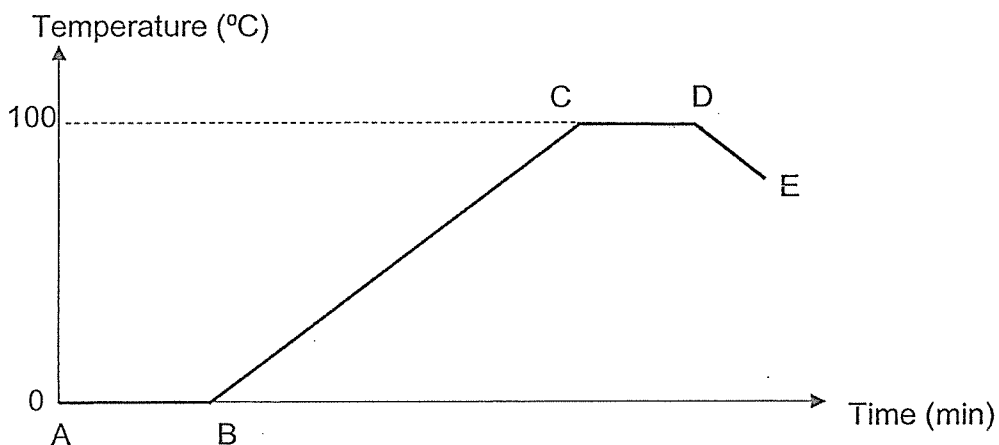

- (a) Which parts of the graph, AB, BC, CD or DE show heat gain by the content in the pan? [1]

- (b) Jeremy also observed tiny water droplets forming on the underside of the lid. After some time, the water droplets stopped forming. Explain why the water droplets have stopped forming on the underside of the lid? [2]

- (c) What would happen to the volume of water in the graph from D to E? Give a reason. [1]

- 38 The diagram below shows an electric cooker hob. The three heating elements are identical and are connected to the mains electricity supply.

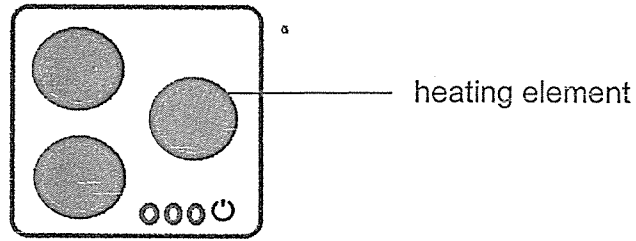

Complete the circuit below to show how the three heating elements are connected using switches to control them independently. [2]

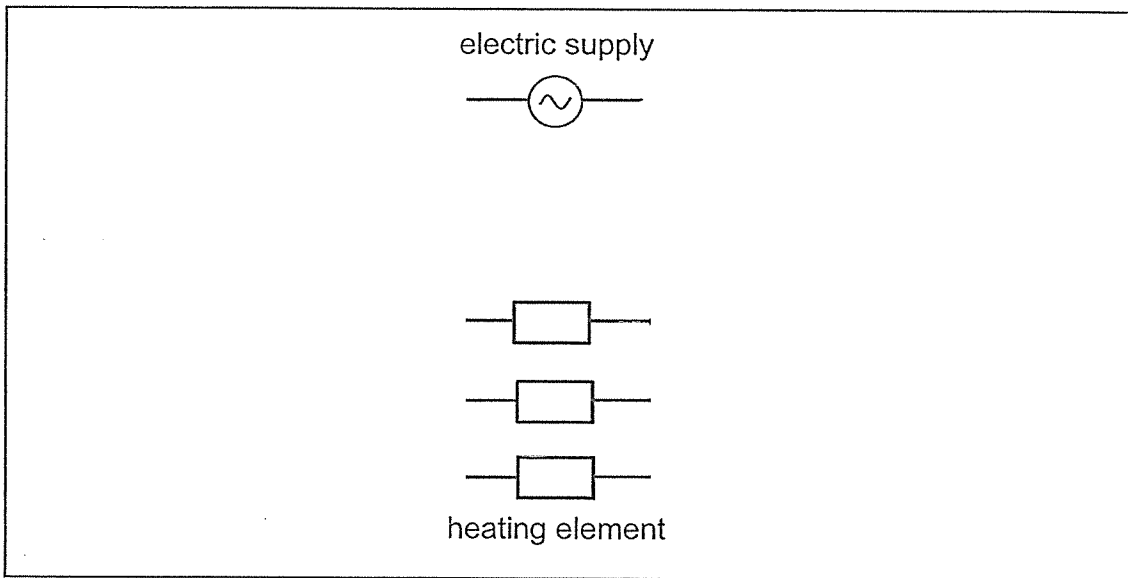

39 The diagram shows a washing machine. When the door is closed and the machine is turned on, an electric motor rotates the drum for washing.

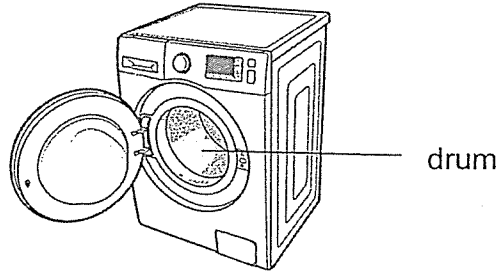

(a) State the energy conversions to wash the clothes. [1]

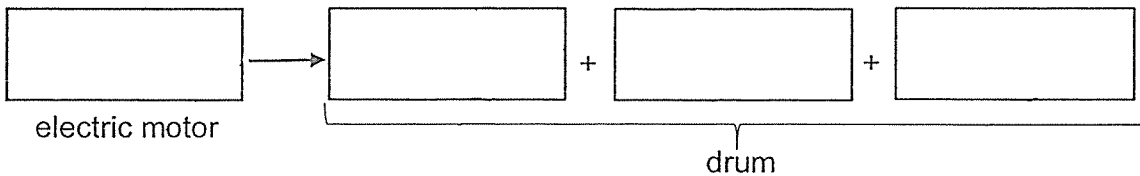

Study the graph below carefully.

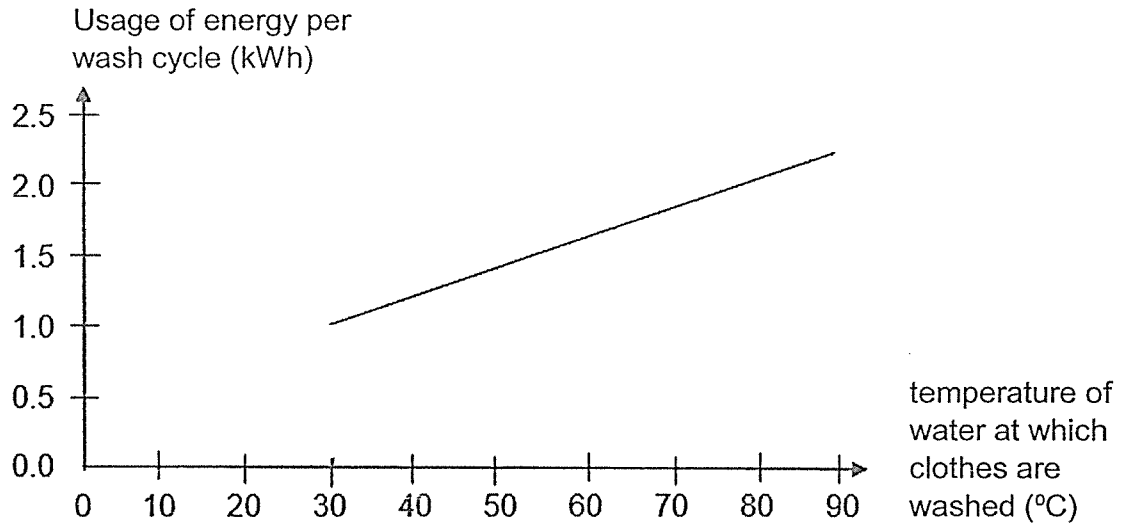

(b) What is the relationship between the temperature of water at which the clothes are washed and the usage of energy? [1]

(c) Explain the relationship in (b) using energy conversion. [1]

40 A man is trying to push a box as shown.

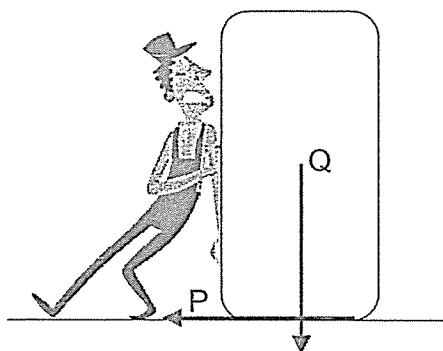

(a) Name the forces, P and Q, acting on the box. [1]

P: _____

Q: _____

(b) State one effect a force can have on an object. [1]

(c) The man found that no matter how hard he pushed, he was not able to move the box. Explain why. [1]

(d) Suggest one way to help the man move the box easily in the direction as shown. [1]

End of paper